

STANDARDOWE INSTRUKCJE TECHNICZNE

Szyny Montażowe



Mounting Rail
Direct



Domestic Rail
35x26mm



40x40



40x60



40x80

Wspólne Elementy Mocujące



Fixed Connector
MRD



Fixed Connector
Domestic



Fixed Connector
40x40, 40x60, 40x80



Flexible
Connector



Cross Connector



Cross Connector
CR



Corner Clamp



Middle Clamp

R3 Bourton Industrial Park, Bourton on the Water, Glos, GL54 2HQ, UK

Tel: +44 1451 824 312

Email: info@sunfixings.co.uk

WWW.SUNFIXINGS.CO.UK

V042018

2

Używając kanałów w szynach montażowych



Szyna
montażowa



Śruba T-bolt

Wsunąć śrubę T-bolt do odpowiedniego kanału szyny
montażowej.

Zablokować śrubę we właściwym miejscu, przekręcając ją
w prawo do momentu, w którym dolna linia gwintu przetnie
powierzchnię szyny.

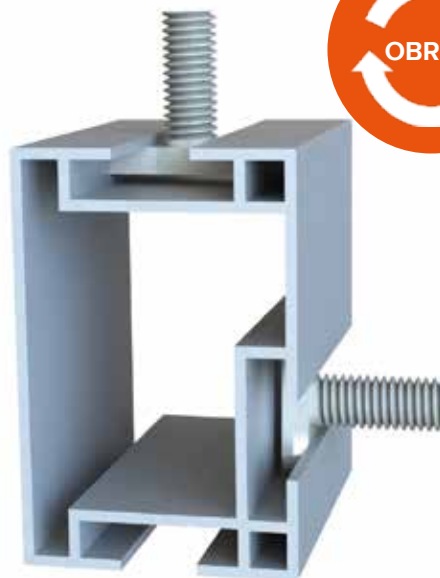
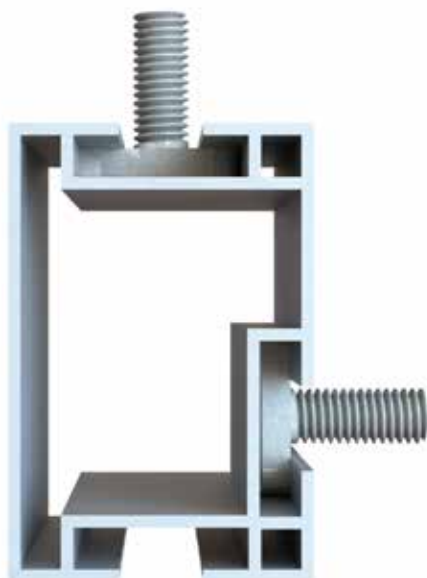

3

Montaż Fixed Connektorów

Mounting Rail Direct



8mm Gniazdo przejściowe



Wkrętarka Akumulatorowa (NIE Udarowa)

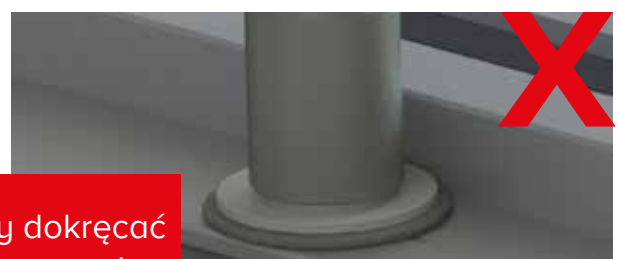
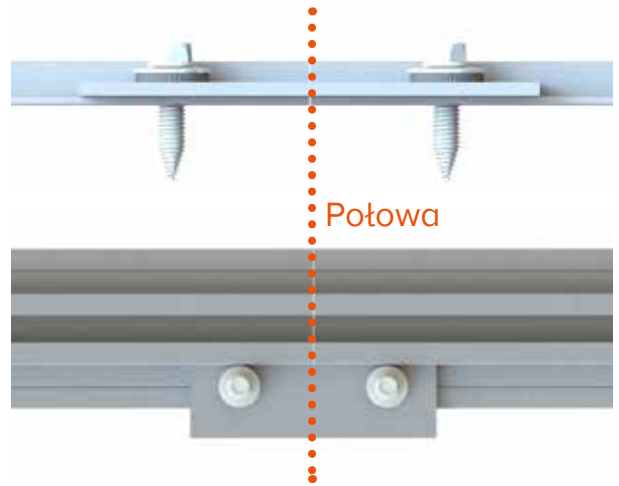
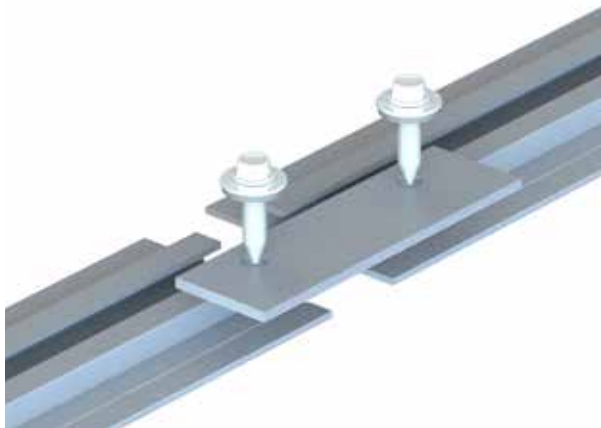

Nie należy dokręcać zbyt mocno ani miażdżyć podkładki

Domestic Rail



13mm Klucz



25Nm



40x40, 40x60 & 40x80



13mm Klucz

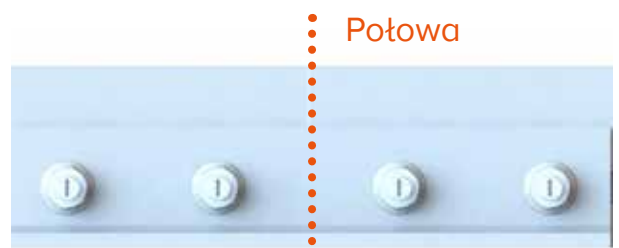
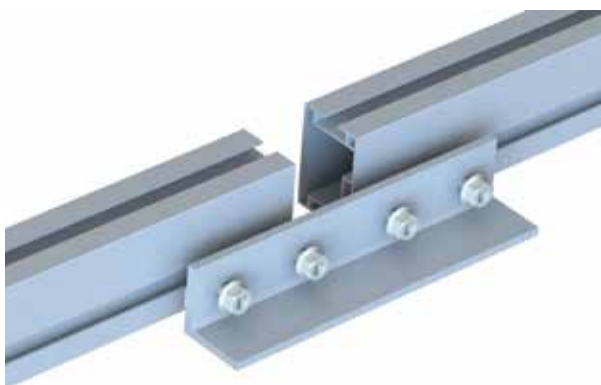

25Nm



4

Montaż Flexible Connectorów



13mm Klucz

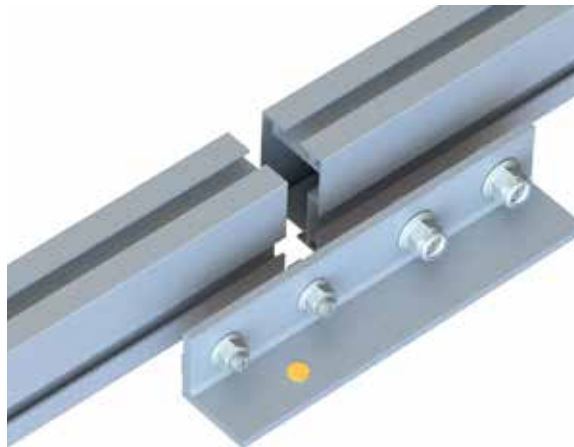

Elastyczne złącze jest identyfikowane przez pomarańczową naklejkę.

Zostaw odstęp 20mm między szynami montażowymi.

Umieść elastyczne złącze centralnie przez lukę 20mm.

Elastyczne złącza są tylko używane dla szyn 40x40, 40x60 i 40x80.

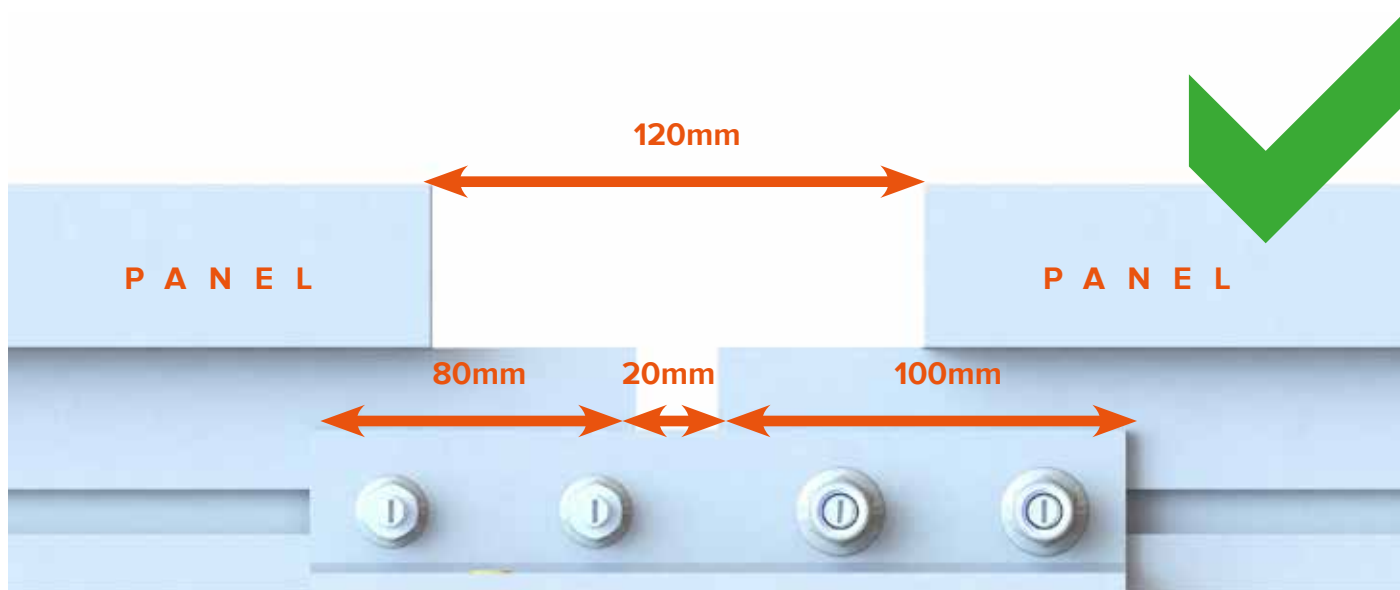

25Nm



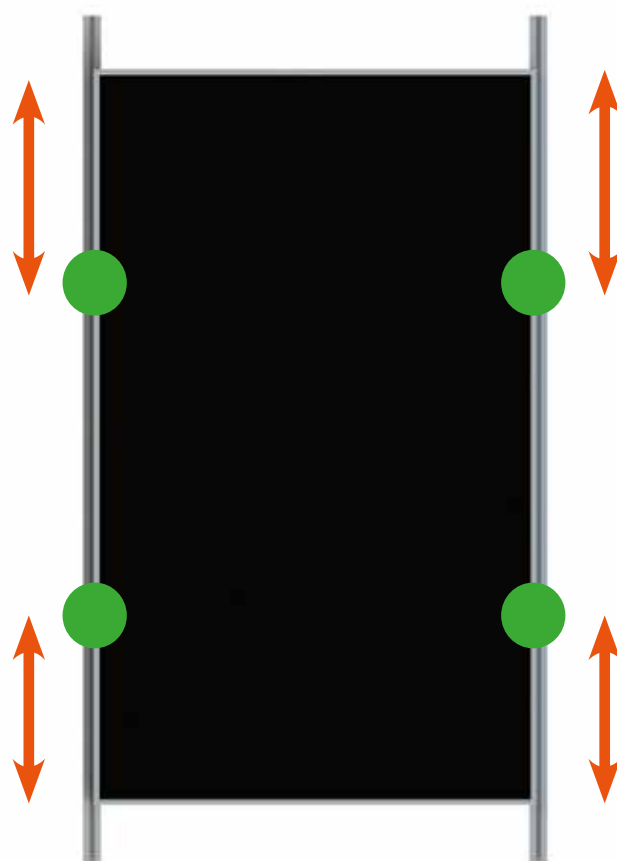

1 Moduł =
4 pozycje
mocowań

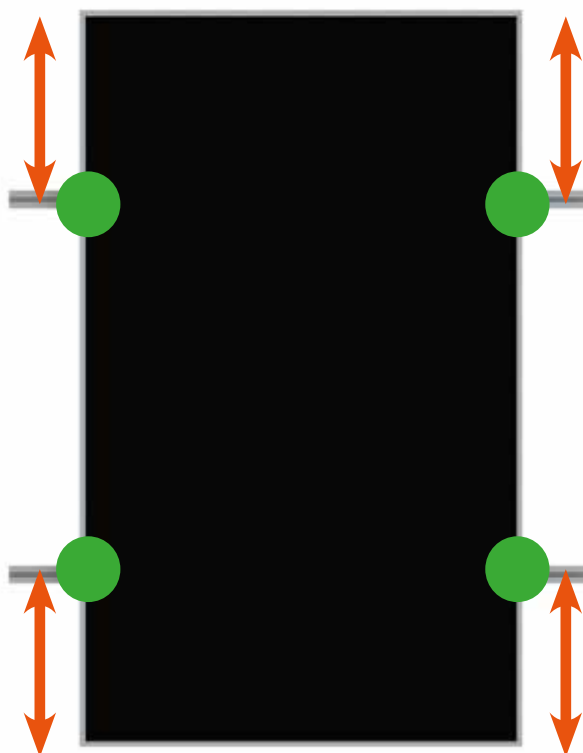

Sprawdź z
producentem
strefy
zaciskania

6

Montaż Corner Clampów

Corner Clamp



8mm Klucz
Imbusowy

Dopasować wysokość Corner Clampu do wysokości ramy modułu
przez kliknięcie w górę albo w dół.

30mm
35mm
40mm
45mm
50mm

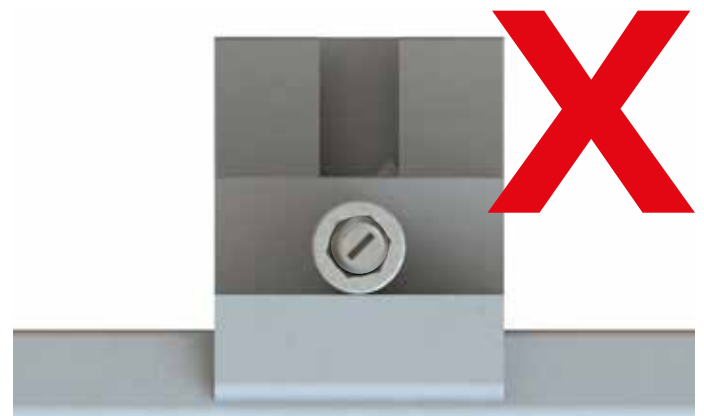
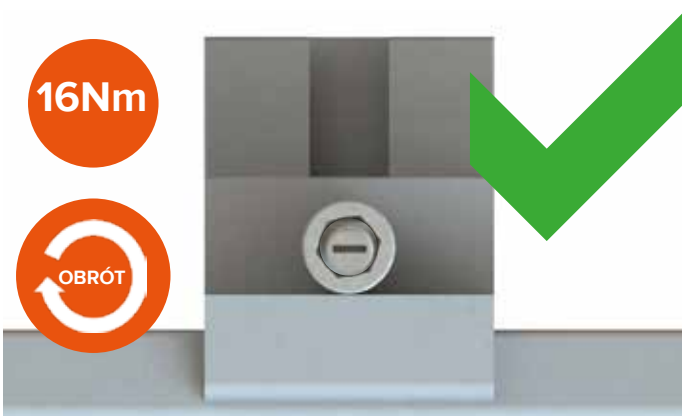
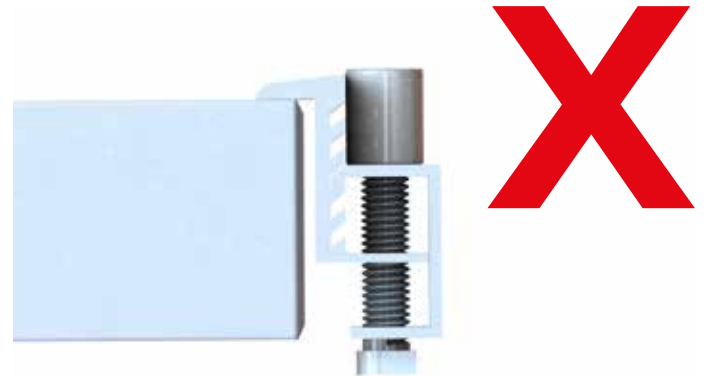
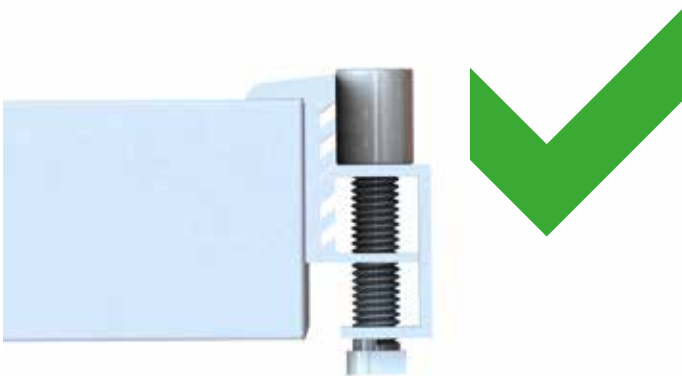
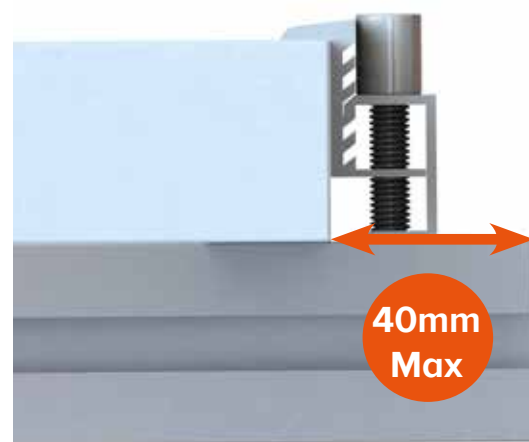
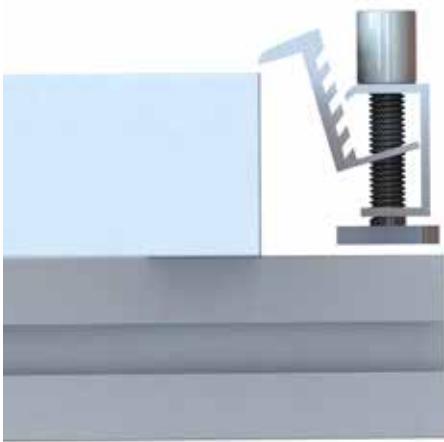

7

Montaż Middle Clampów

Middle Clamp



8mm Klucz Imbusowy

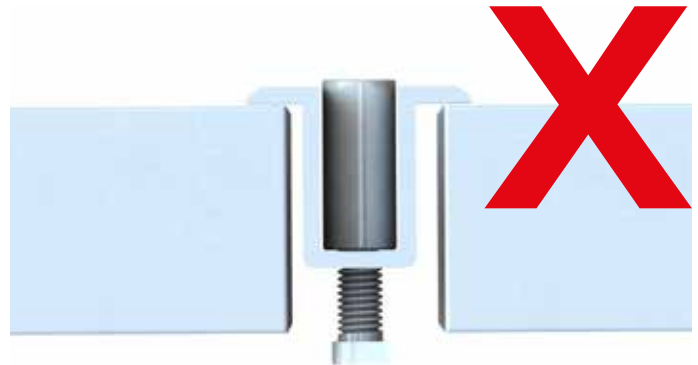
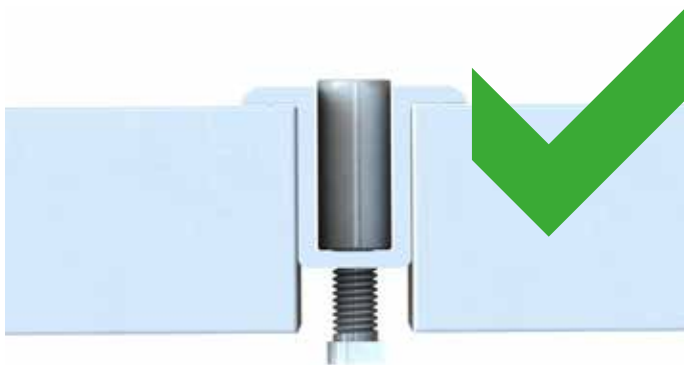
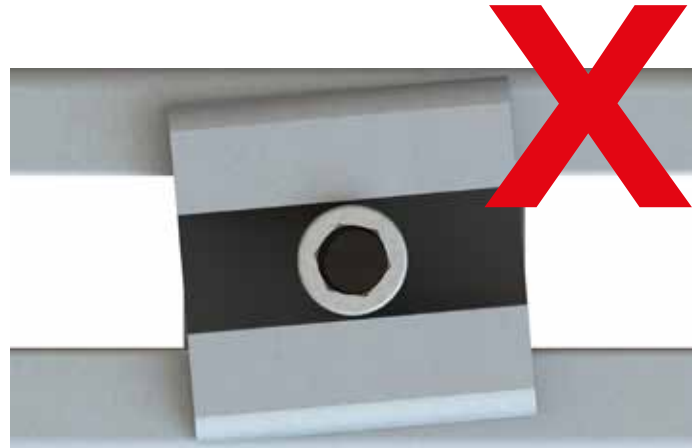
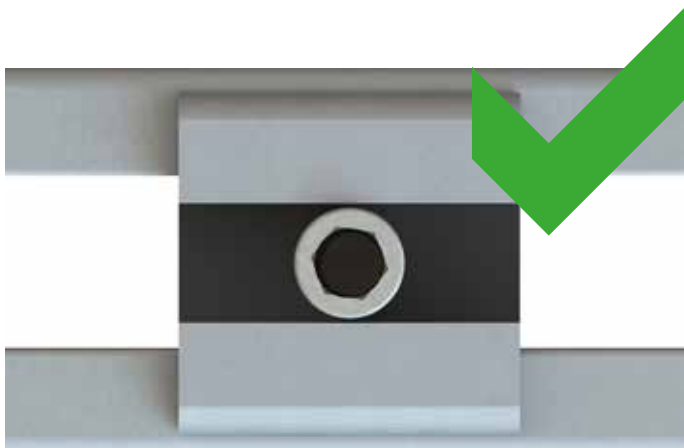
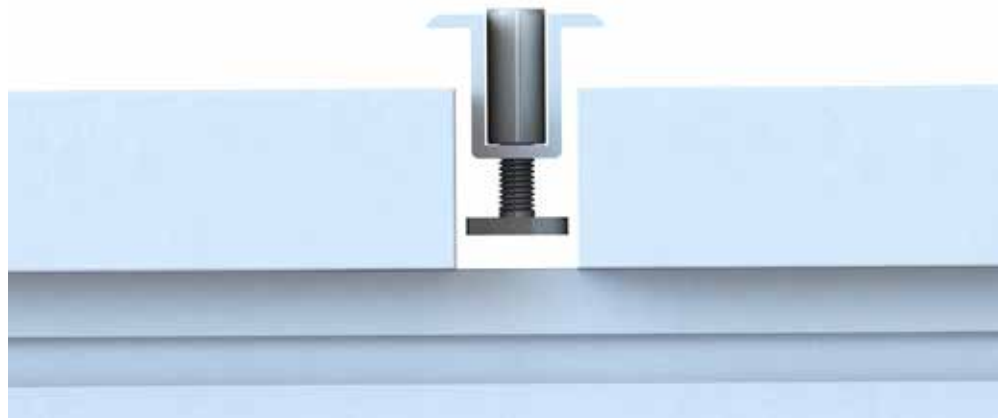

Cross Connector



13mm Klucz

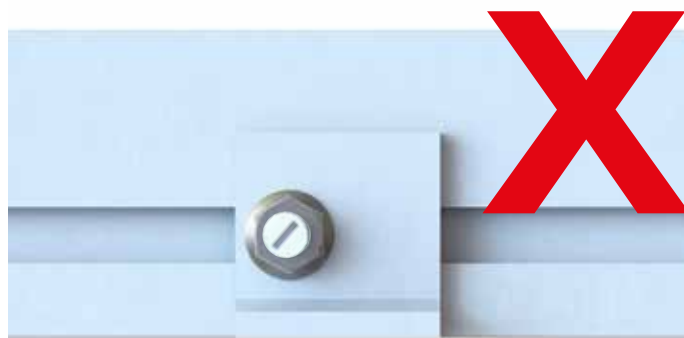
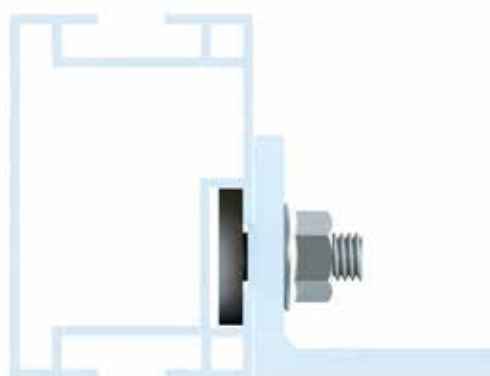
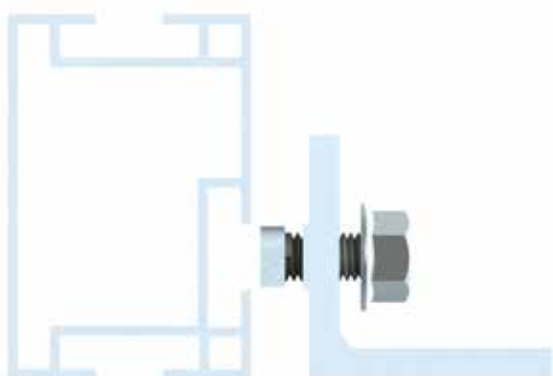
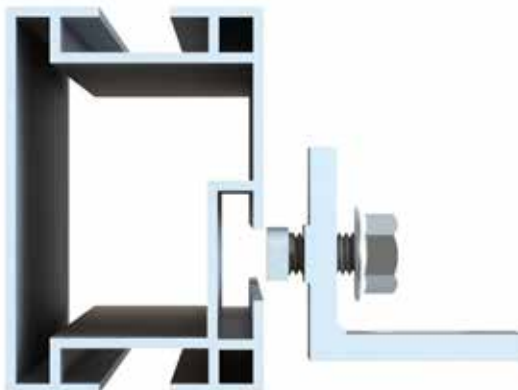

25Nm



Cross Connection



13mm Klucz

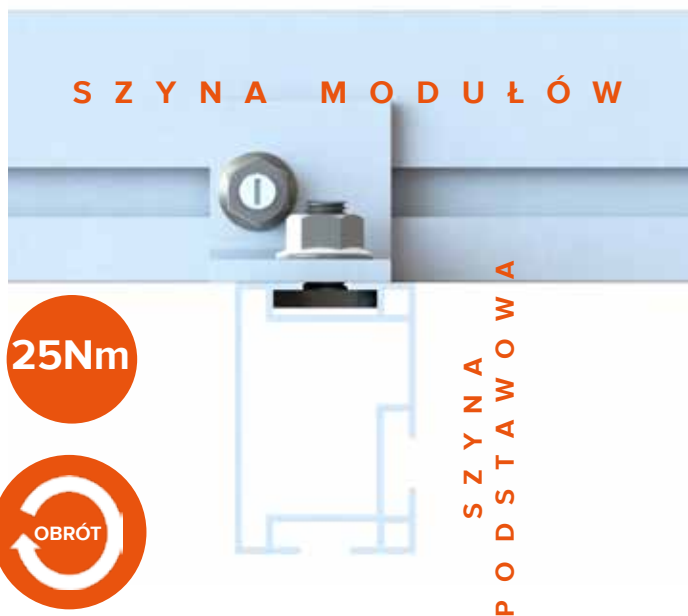
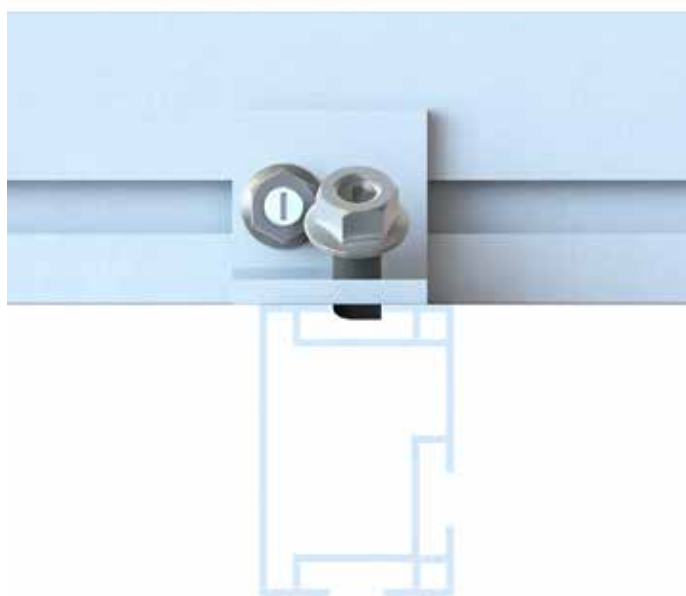
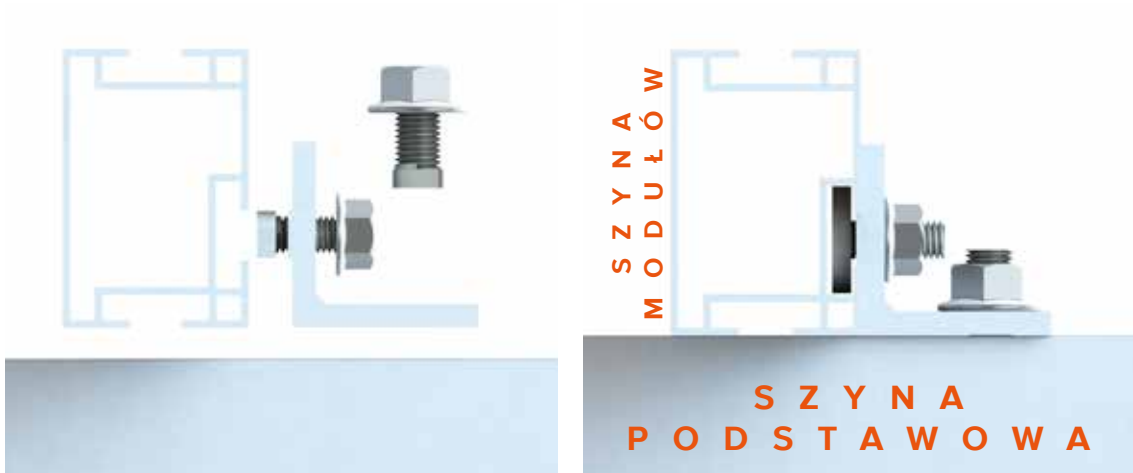

25Nm

