

Standardní **Technické Pokyny**

Montáž profilů kolejnic



Montážní lišta
Direct



Domestic Rail
35x26mm



40x40



40x60



40x80

Společné součásti



Fixed Connector
MRD



Fixed Connector
Domestic



Fixed Connector
40x40, 40x60, 40x80



Flexible
Connector



Cross Connector



Cross Connector
CR



Corner Clamp



Middle Clamp

R3 Bourton Industrial Park, Bourton on the Water, Glos, GL54 2HQ, UK

Tel: +44 1451 824 312

Email: info@sunfixings.co.uk

WWW.SUNFIXINGS.CO.UK

V042018

2

Použití kanálů v montážních lištách



Montážní lišta



Šroub T

Vložte šroub T do příslušného kanálu montážní lišty.

Zajistěte otočením šroubu T po směru hodinových ručiček, dokud čára v dolní části závitu nepřekročí směr montážní lišty.

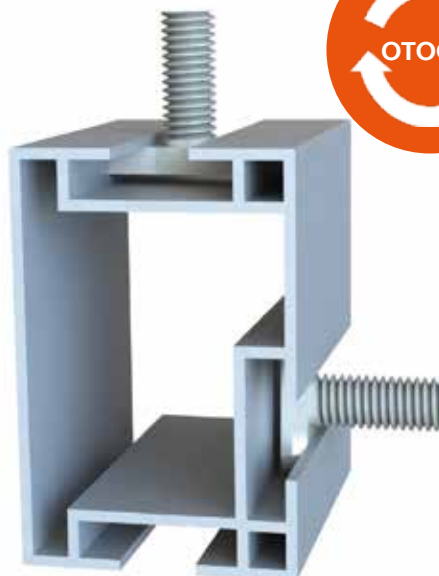
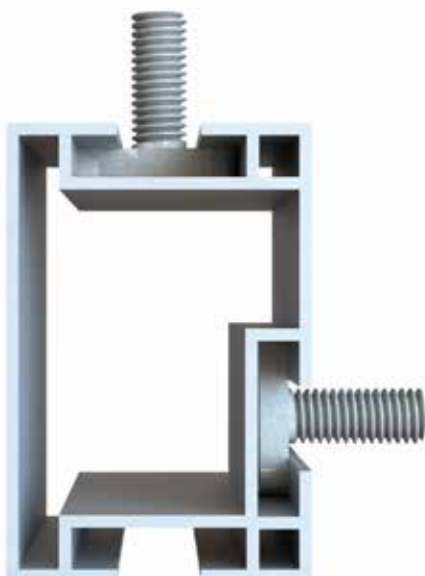

3

Instalace pevných konektorů

Mounting Rail Direct



8mm šroub se šestihrannou hlavou



Bateriová vrtačka (NE sbíječka)

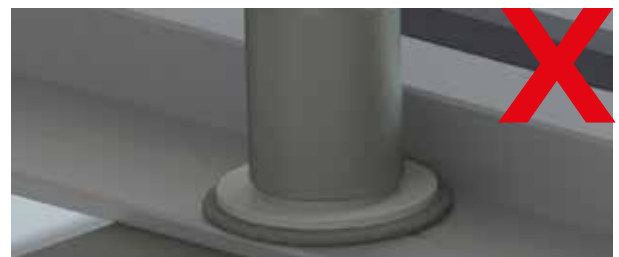
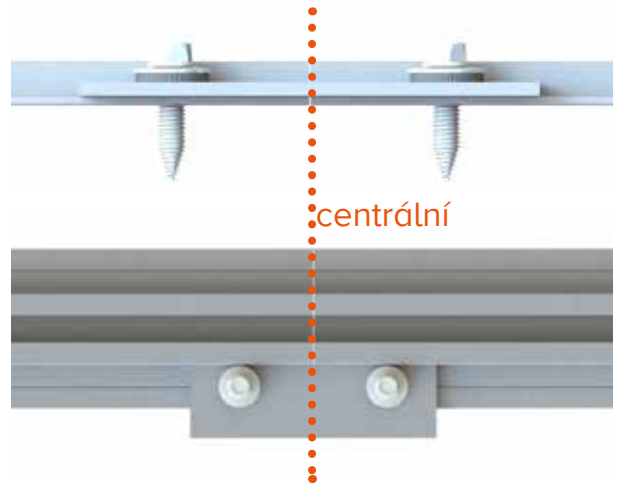
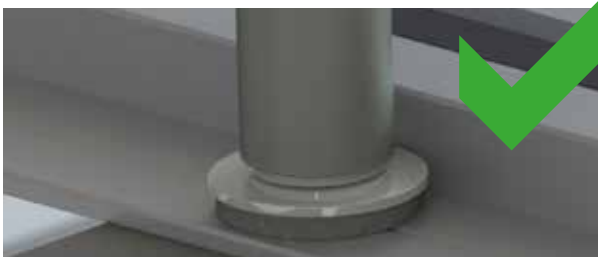
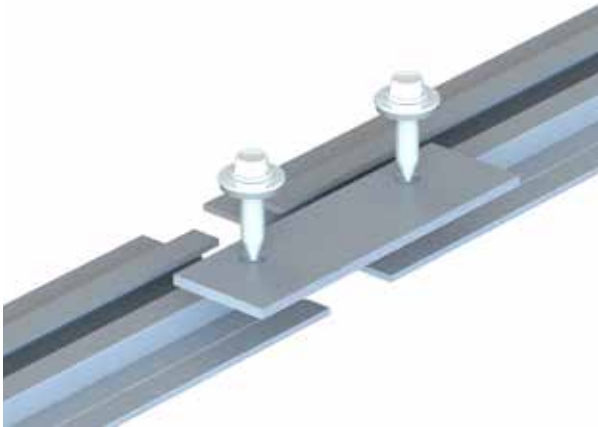

NEUTAHUJTE těsnění příliš těsně a nemačkejte jej.

Domestic Rail



Klíč 13mm

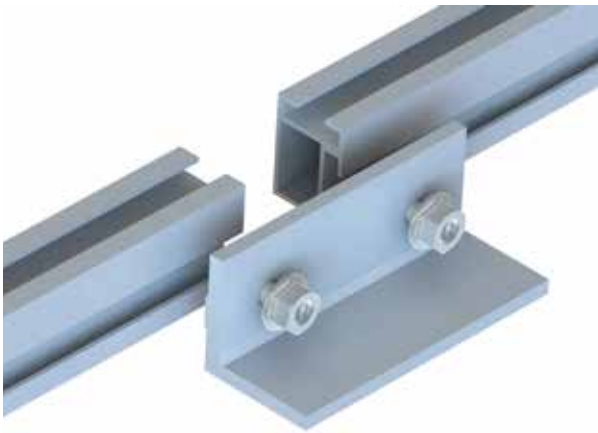

25Nm

OTOČIT

40x40, 40x60 & 40x80



Klíč 13mm

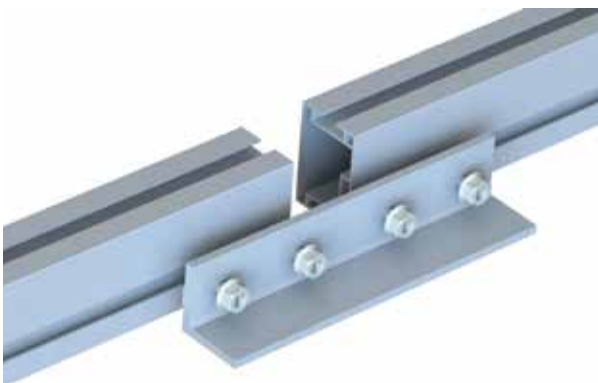

25Nm

OTOČIT

4

Instalace flexibilního konektoru



Klíč 13mm

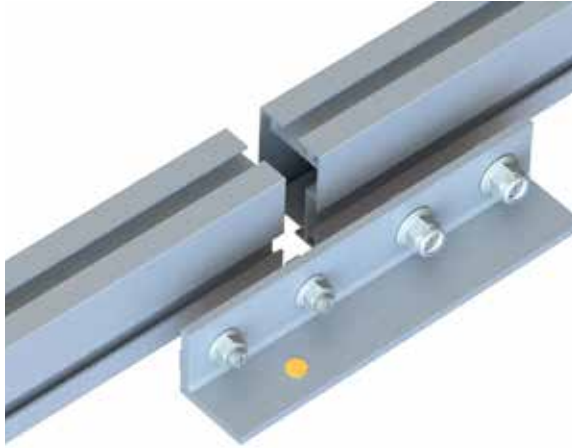

Flexibilní konektor je označen oranžovým kruhem.

Ponechejte mezi montážními lištami 20 mm mezery.

Umístěte flexibilní konektor do středu přes 20 mm mezeru.

Flexibilní konektory se používají POUZE pro 40x40, 40x60 a 40x80.

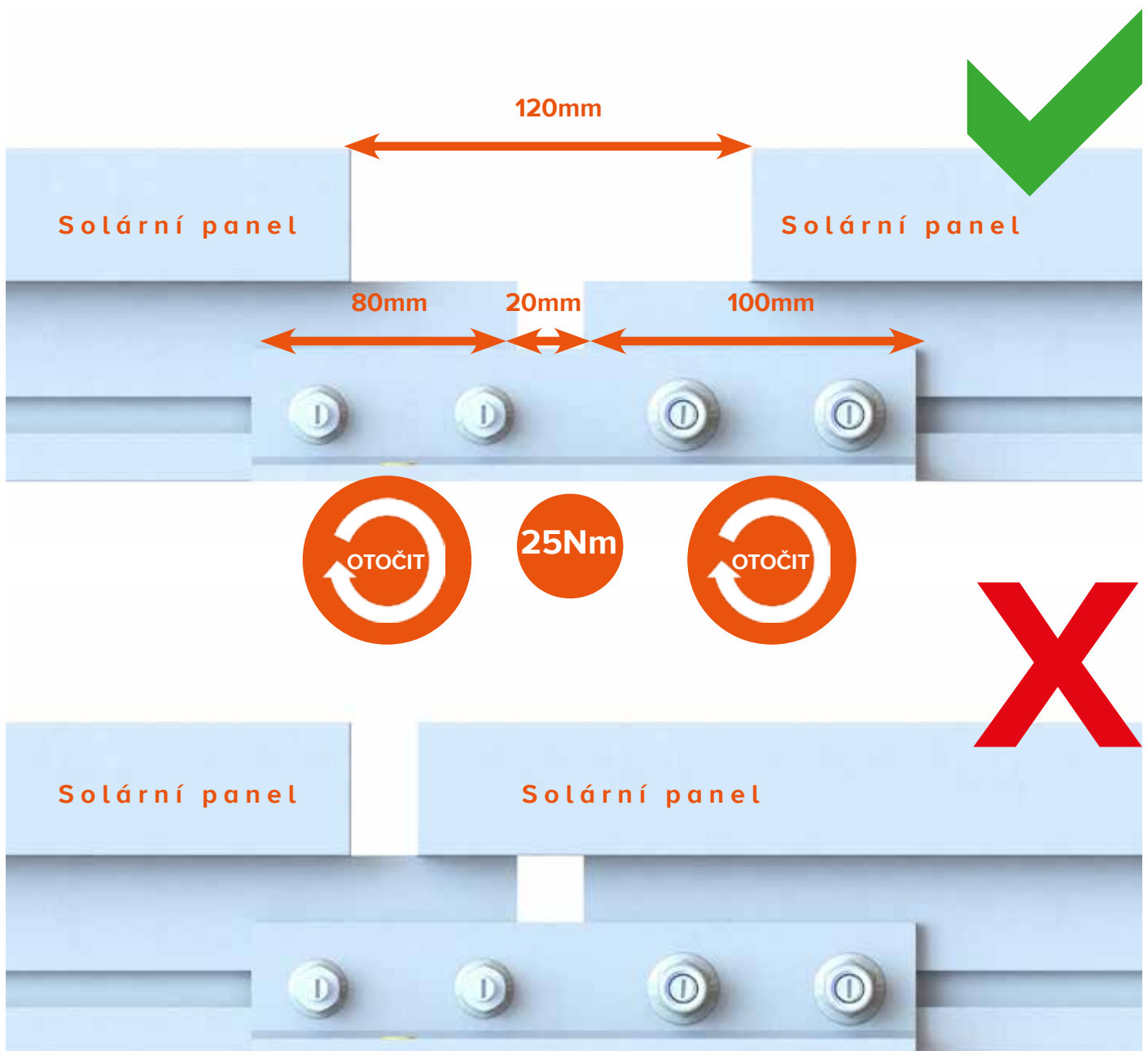

5

Pozice svorek solárního panelu

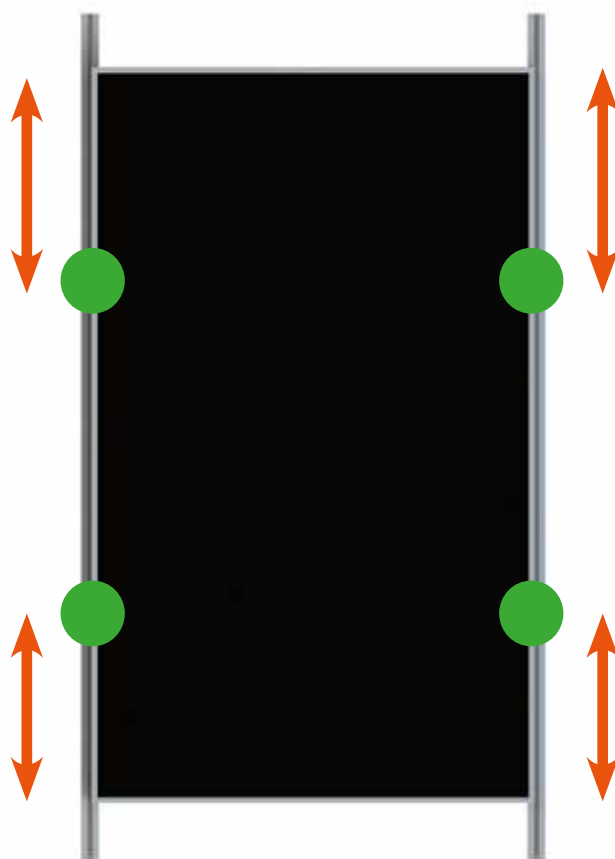

1 solární panel
= 4 pozice
připevnění

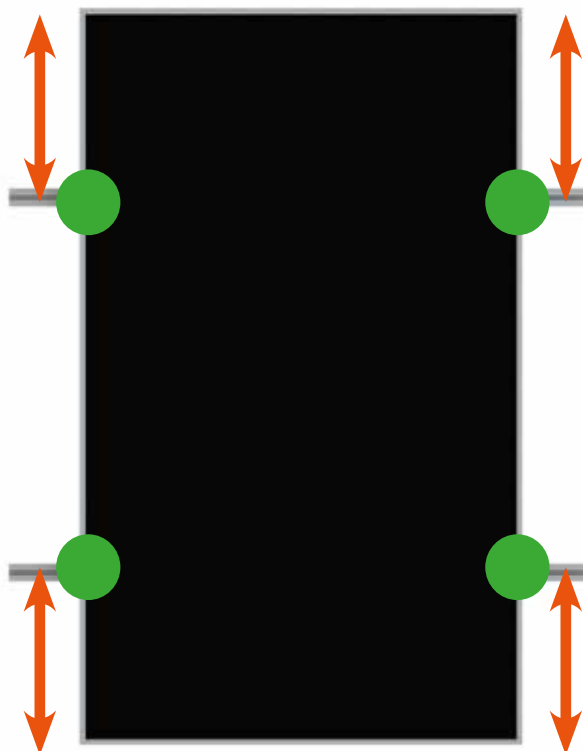

Zkontrolujte
upínací zóny
s výrobcem
solárního
panelu.

6

Instalace rohových svorek

Corner Clamp



8mm imbus

Kliknutím nahoru nebo dolů nastavte výšku rohové svorky tak, aby odpovídala hloubce solárního panelu.

30mm
35mm
40mm
45mm
50mm

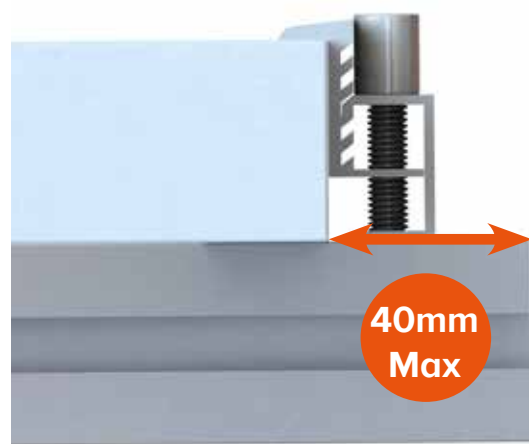
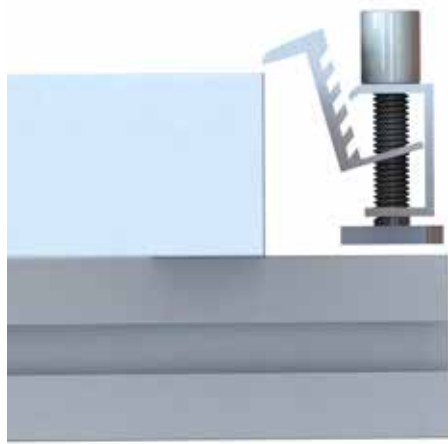

40mm
Max

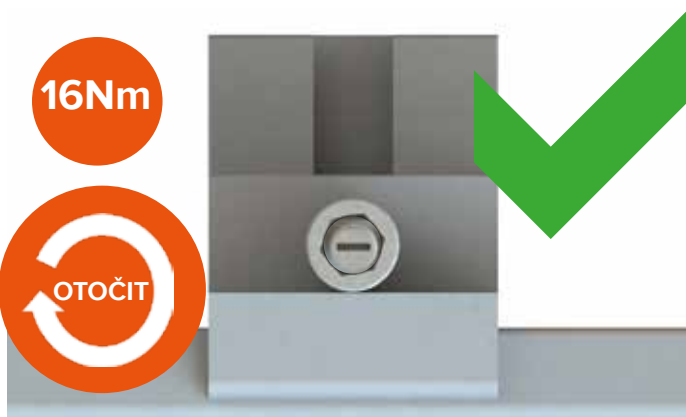
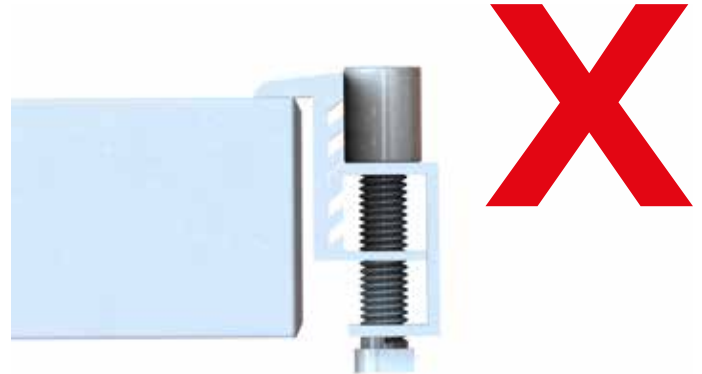
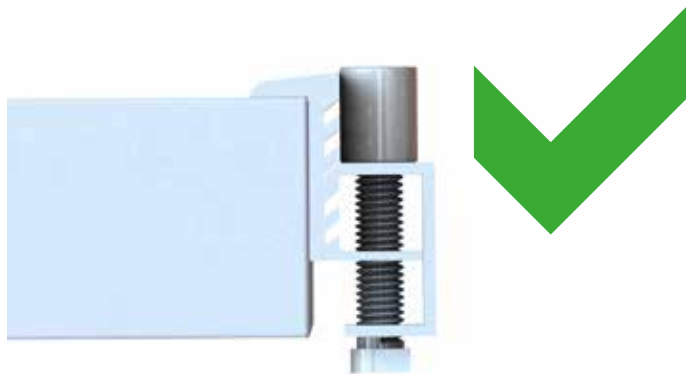

16Nm

OTOČIT

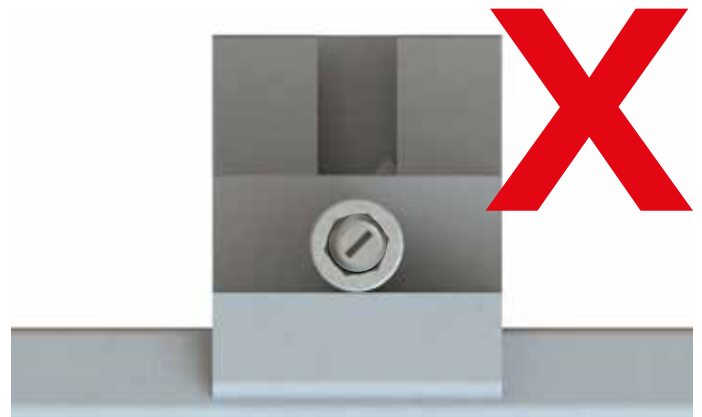

7

Instalace středních svorek

Middle Clamp



8mm imbus

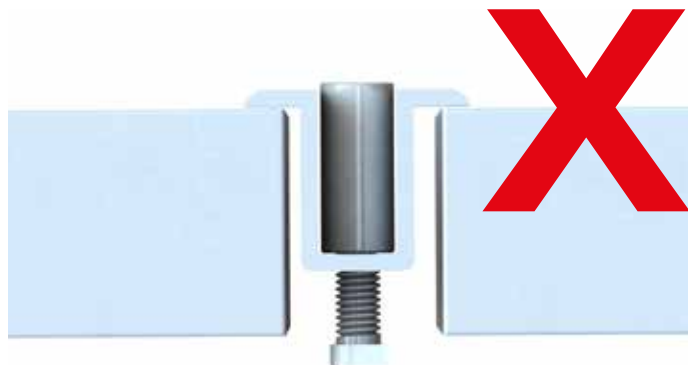
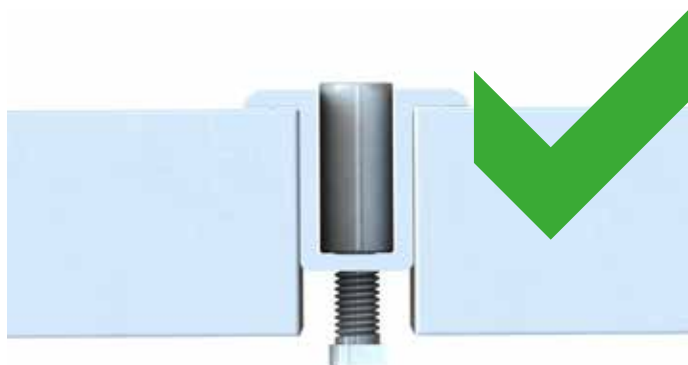
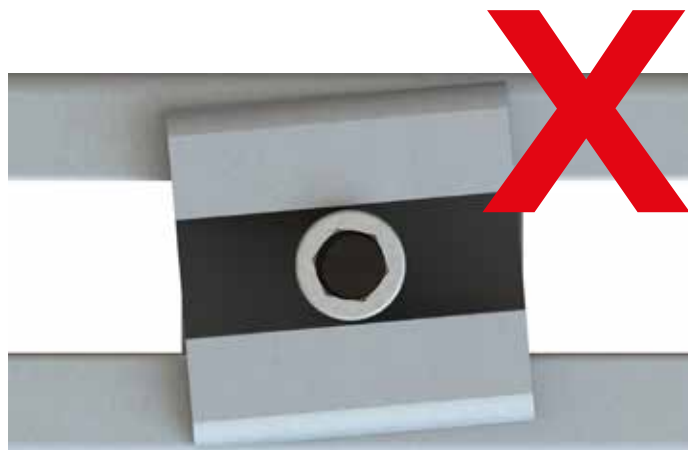
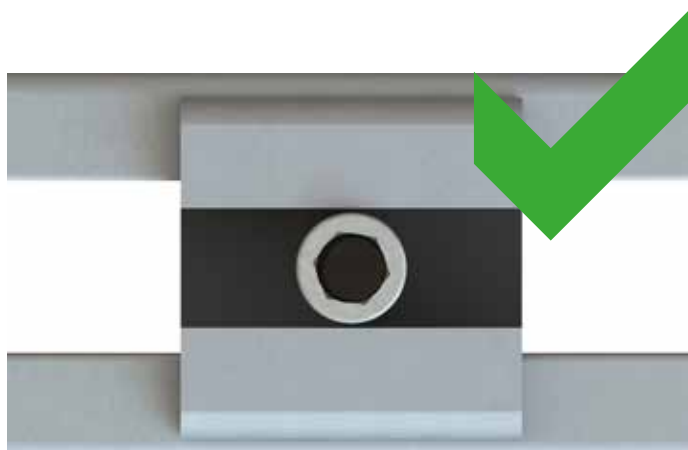
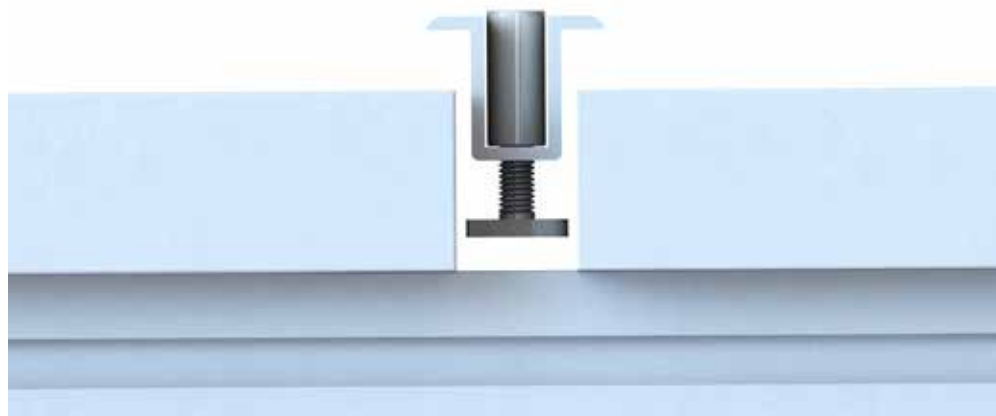

8

Instalace Cross Connector

Cross Connector



Klíč 13mm

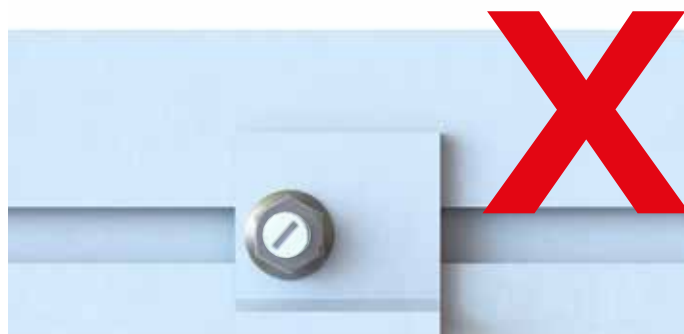
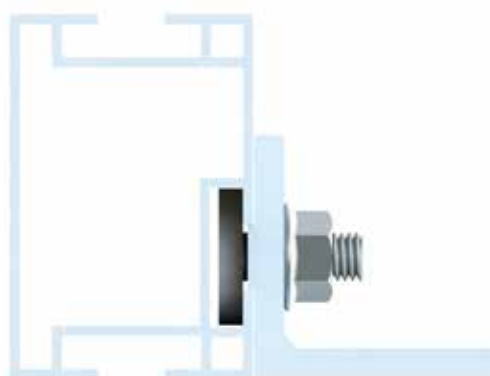
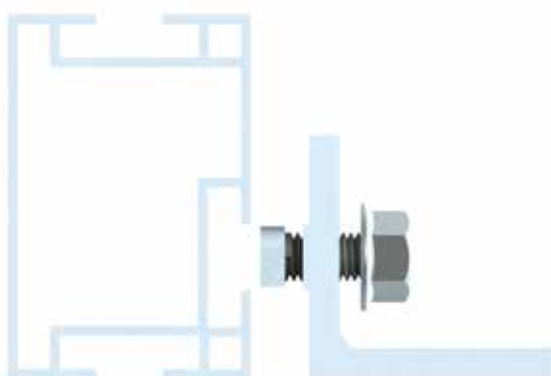
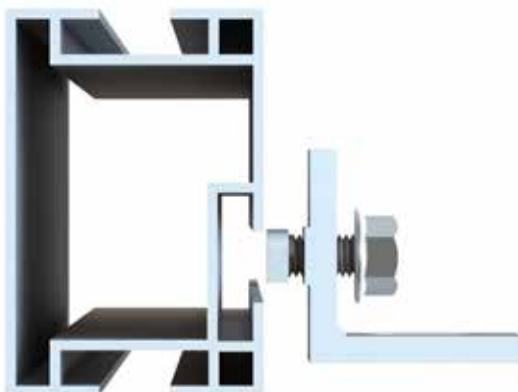

25Nm

OTOČIT

Cross Connection



Klíč 13mm

