



# ROOF **HOOK**



R3 Bourton Industrial Park, Bourton on the Water, Glos, GL54 2HQ, UK

**Tel: +44 1451 824 312**

**Email: [info@sunfixings.co.uk](mailto:info@sunfixings.co.uk)**

**[WWW.SUNFIXINGS.CO.UK](http://WWW.SUNFIXINGS.CO.UK)**

V072017

# 2

## The Roof Hook

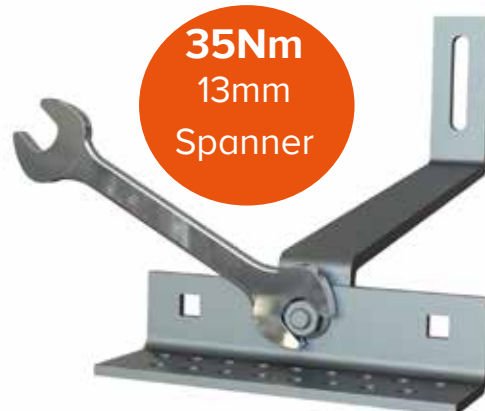
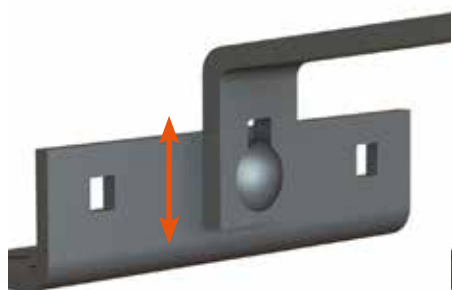
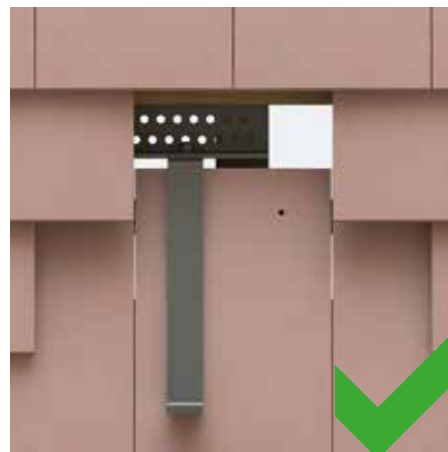
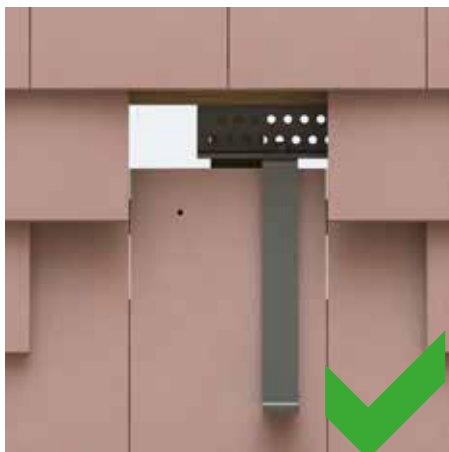
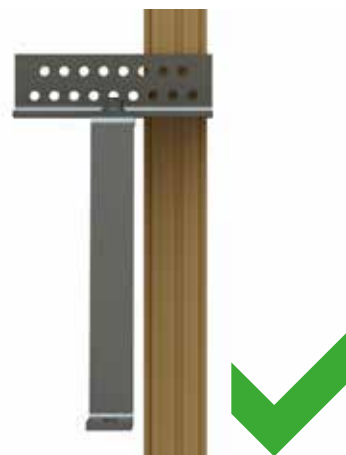
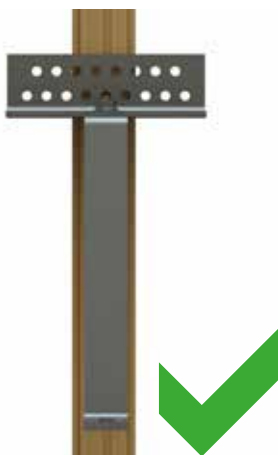
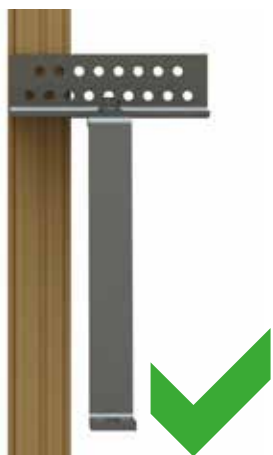

**35Nm**  
13mm  
Spanner

# 3

## Locate the rafters & remove roofing tiles

### Tools & Items Required



Layout



Roofing Tile

Use the layout to confirm the location of the Roof Hooks.  
Locate where the rafter is and remove the roofing tiles.

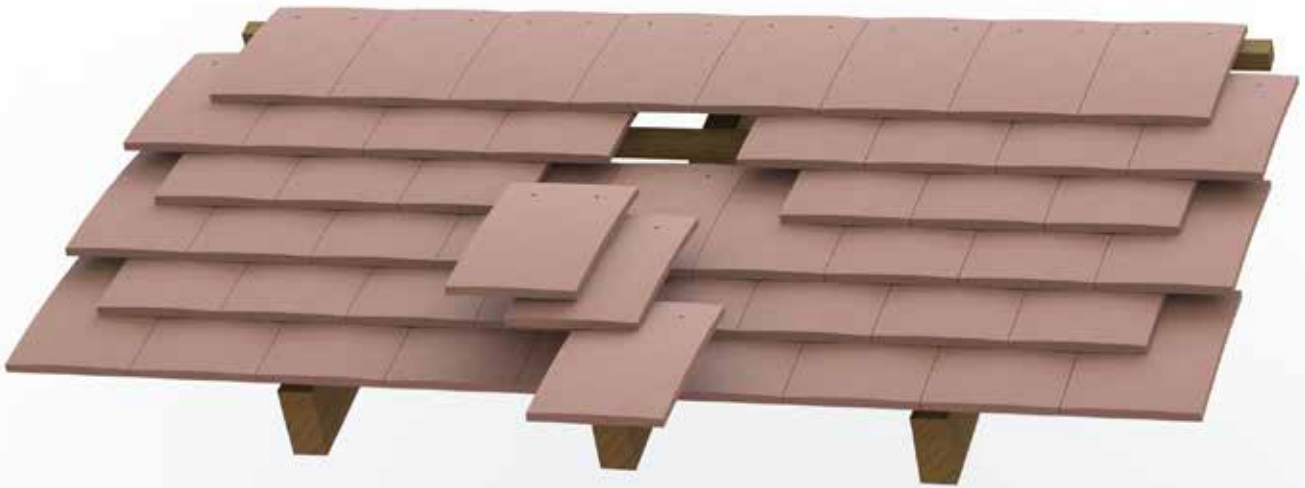

# 4

## Mark the position of the Roof Hook on the roofing tile

### Tools & Items Required



Roofing Tile



Roof Hook



Chalk or  
Builder's Wax

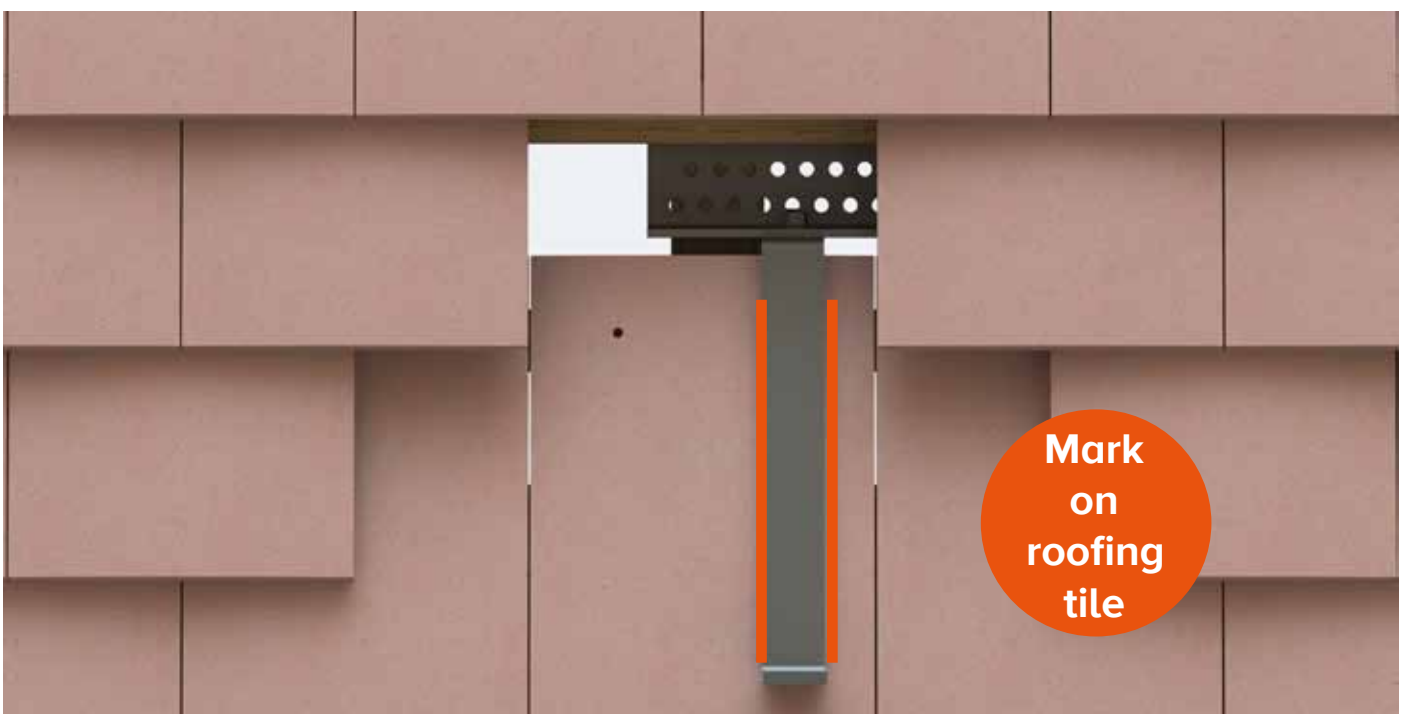
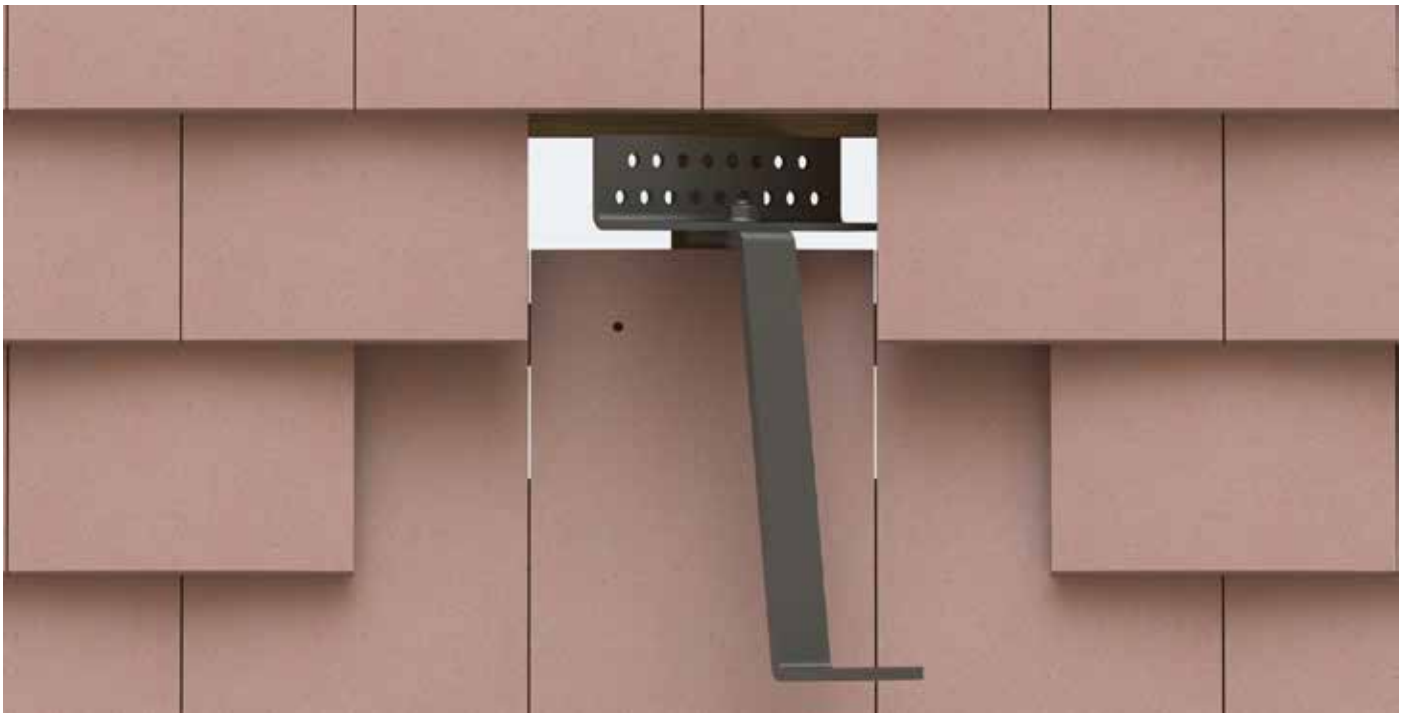

# 5

Gently brush (grind) the marked position

## Tools & Items Required



Grinder



Roofing Tile

The Roof Hook should not rest on the bottom tile. The top tile should sit level with the rest of the tiles.

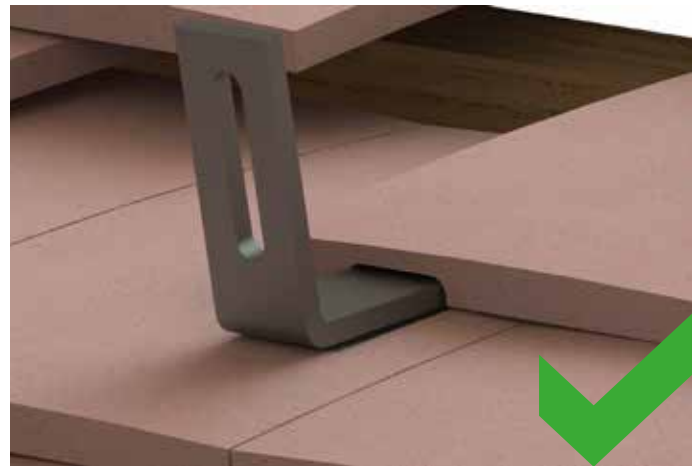
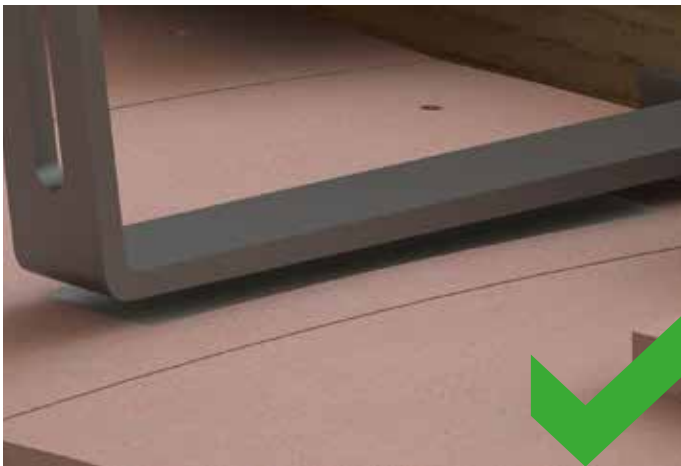

# 6

## Fitting the Roof Hook

### Tools & Items Required



Battery Drill  
(NOT Impactor)



Screw Bit



Roof Hook



Wood Screw

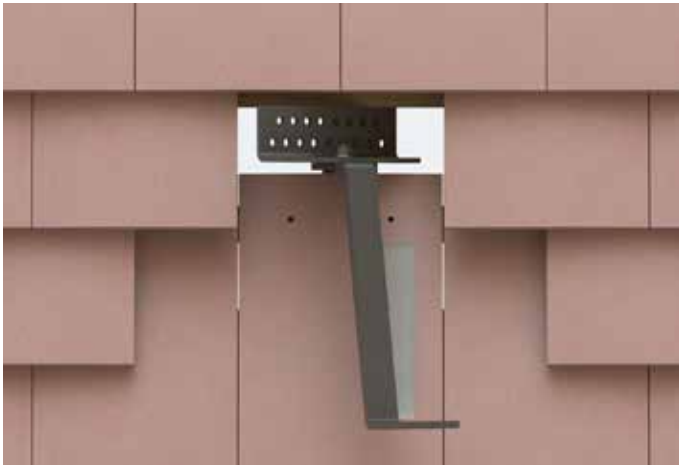

2 wood  
screws

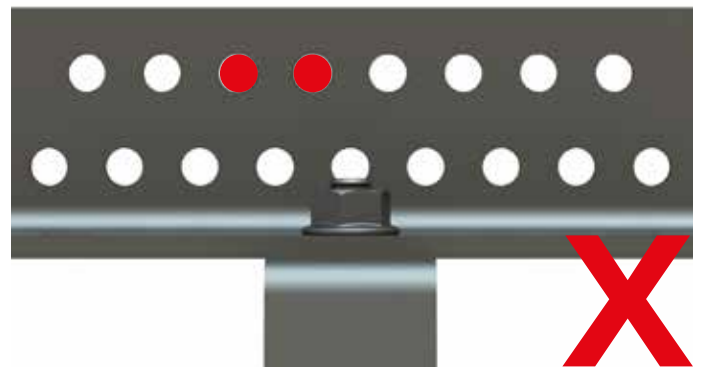
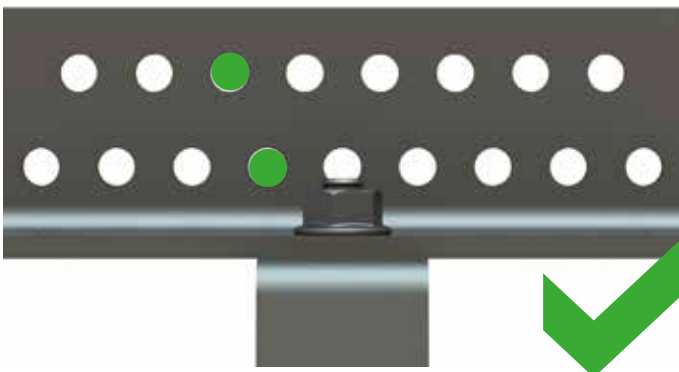

# 7

## Replace roofing tiles

